

修訂 / Revision					
記號 / MARK	版本 / REV	修訂內容 / DESCRIPTION	變更單 / EN	日期 / DATE	繪圖 / DWN
1.0	1.0	新增產品單重 NEW VERSION	王蓓	2013.01.09	紀冬青
1.1	1.1	新增392432024ACH打點標記	王蓓	2013.10.18	王蓓

NOTE:
1. ALL THE DIMENSIONS ARE MEASURED UNDER GRADE "P" UNLESS OTHERWISE SPECIFIED.
2. WEIGHT: 22.15g.

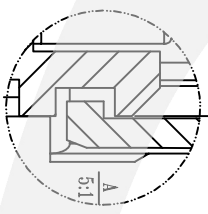
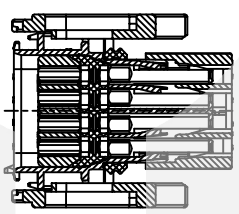
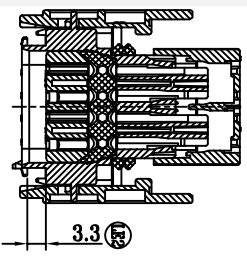
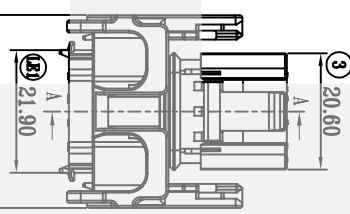
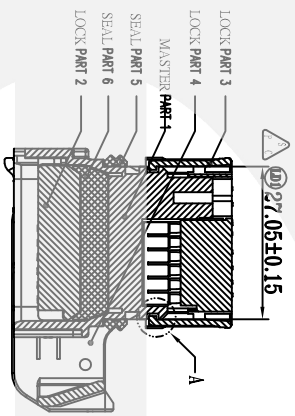
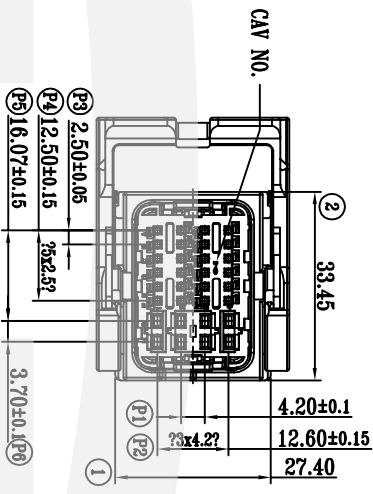
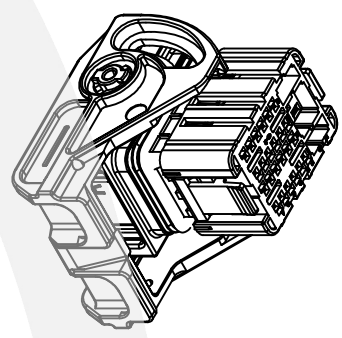

SEAL	NO.	產品編號 / Part Number	構成零件 / Composed parts	材質 / Material	顏色 / Color	對子件 / Counter P/No.	配合端子 / Applicable Ter.
SEAL	6	R02432024AQR	---	SILICONE	RED	---	---
SEAL	5	R02432024ARR	---	SILICONE	RED	---	---
LOCK	4	392432024AEB	---	PBT-GF15	BLACK	---	---
LOCK	3	392432024DDH	---	PBT-GF15	GRAY	---	---
LOCK	2	392432024ACH	---	PBT-GF15	GRAY	---	---
MASTER	1	392432024AMB	---	PBT-GF15	BLACK	---	805002
F.P.	-	392432024DAB	1+2+3+4+5+6	---	---	---	820001

材料 / MATERIAL	表面處理 / FINISH	核發單位 / ISSUED BY	制定單位 / INSTITUTED BY	核准 / 校核 / 審核 / 制定 / 繪圖 / APPROVED BY / CHECKED BY / DRAWN BY / DRAWER
SEE TABLE	SEE TABLE	王蓓	王蓓	王蓓

一般公差 / Tolerances unless other specified	圖名 / DRAWING NAME
GRADE A <100 : ±0.15 >100 : ±0.20	025 TYPE FEMALE HOUSING
GRADE B <100 : ±0.30 >100 : ±0.50	060 DRAWING NUMBER
>1000 : ±0.50 >2500 : ±0.75 ANGLE : ±30'	392432024DA

核發單位 / ISSUED BY	制定單位 / INSTITUTED BY	核准 / 校核 / 審核 / 制定 / 繪圖 / APPROVED BY / CHECKED BY / DRAWN BY / DRAWER	圖紙 / 單位 / 比例 / 頁數 / 頁碼 / CODE
2013.10.18 研發部	2013.10.18 研發部	2013.10.18 賴劍平 / 2013.10.18 余鄭軍 / 2013.10.18 張輝 / 2013.10.18 王蓓	圖紙: A3 / 單位: mm / 比例: 1:1.3 / 頁數: 1/1 / 頁碼: 1/1 / CODE: N21



胡連精密股份有限公司
Hu Lane Associate Inc.

Hu Lane Associate Inc. 產品規格圖